

\*

S

( )

Mishra et al., 2007

Haines (1923)

(Mishra et )

.al., 2007

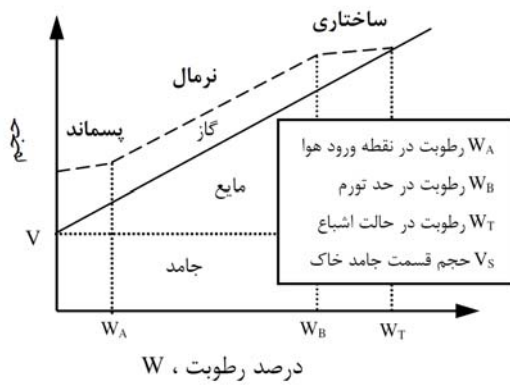

(Gaurley et al., 1993)

Tripathy et )

(al., 2002

Haines (1923)

Structural )

(shrinkage

(e)

(w)

Normal )

(shrinkage

\*

( )

۸۸	حدروانی (C)
۳۱	حد خمیری (C)
۵۷	شاخص خمیری (C)
۱۳	حدانقباض (C)
۲/۷۵	وزن مخصوص دانه‌های جامد
۷۳	عبوری از الک ۲۰۰ (C)
۴۸	میزان رس (کوچکتر از ۰.۰۰۲ میلیمتر) (C)
۲۵	میزان سیلت (C)
۳۷	میزان ماسه ریز (C)
۱/۱۸	فعالیت (A)

(shrinkage Residual)

(

( )

(Oedometer)

)

.(

)

(McKeen, R.G. (1992)

(Kaolin)

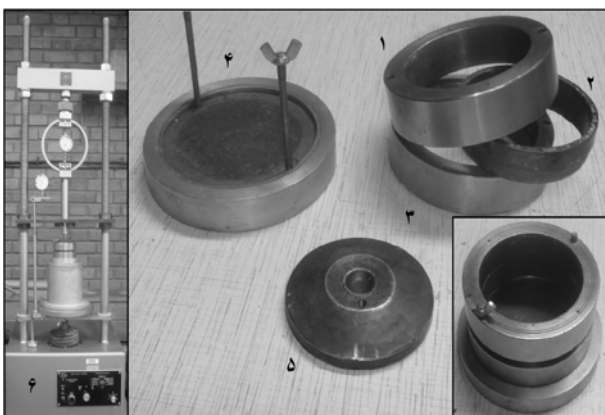

% %

(A)

(PI)

(CH)

: : ( ) : :

w<sub>opt</sub>=20.5 %

γ<sub>d</sub>=16.1kN/m<sup>3</sup>

ASTM

/ ) %  
kN/m<sup>3</sup>

(

/

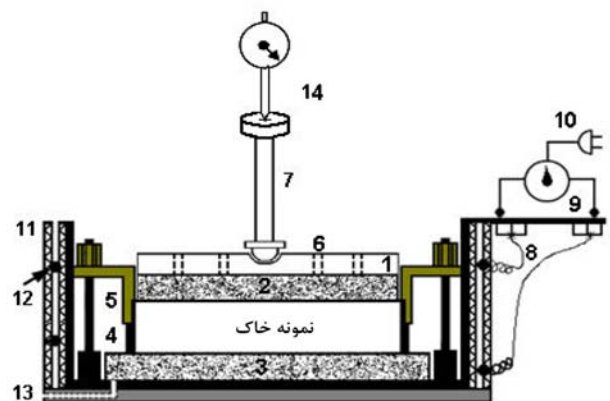

( )

: : : : :  
: : : : :  
: : : : :

( )

( )

$$\Delta e \quad \Delta V$$

$V_0$

( $H_0$ )      ( $\Delta H$ )

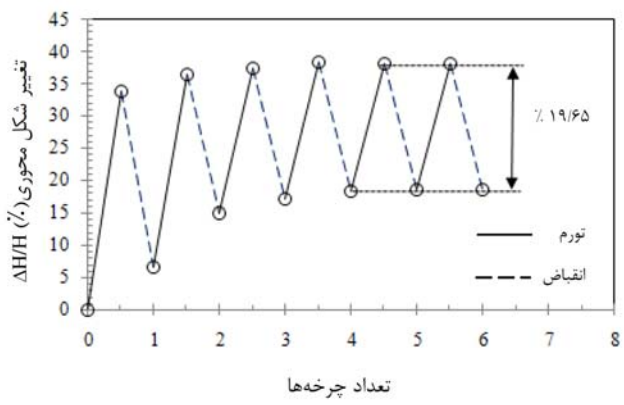

/

/

)

(

( )

$$\frac{\Delta V}{V_0} = \frac{\Delta e}{1+e_0}$$

/

( )

Chen (1965);  
Subba Rao and Satyadas (1987); Chu and Mou (1973)

Adel (1991)

Popescu (1980)

Tawfiq

and Nalbantoglu (2009)

Al-Homoud et al. (1995)

Basma et al. (1996)

(Hysteresis)

(Soil-Water Characteristic Curve)

( )

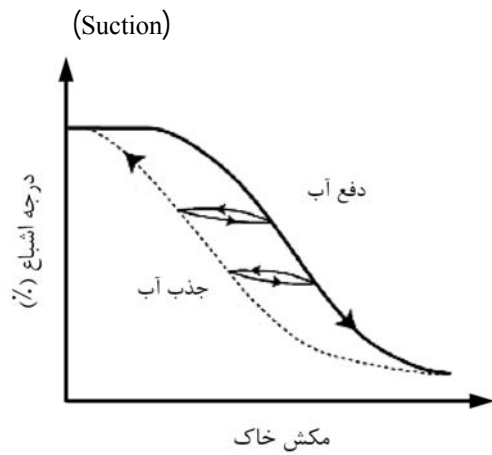

Alonso et al. (1994)

(Barcelona Expansive Model)

(Microstructure)

(Macostructure)

C B

F E D

(w)

(e<sub>0</sub>)

(A )

B

B

A

( )

C

( )

( )

C

(Gens and Alonso., 1992)

D

D

( )

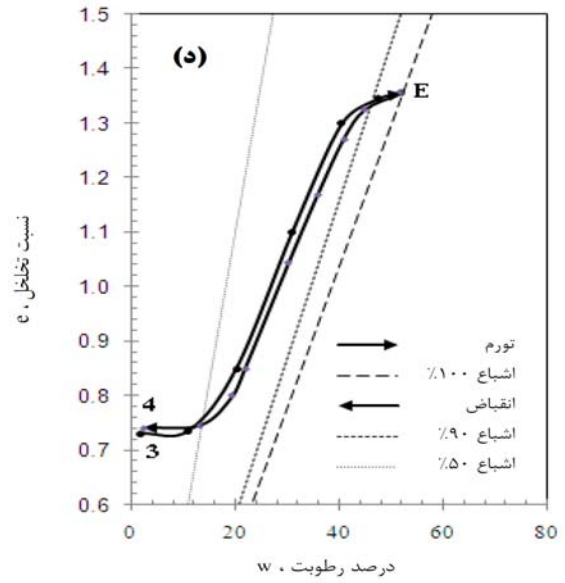
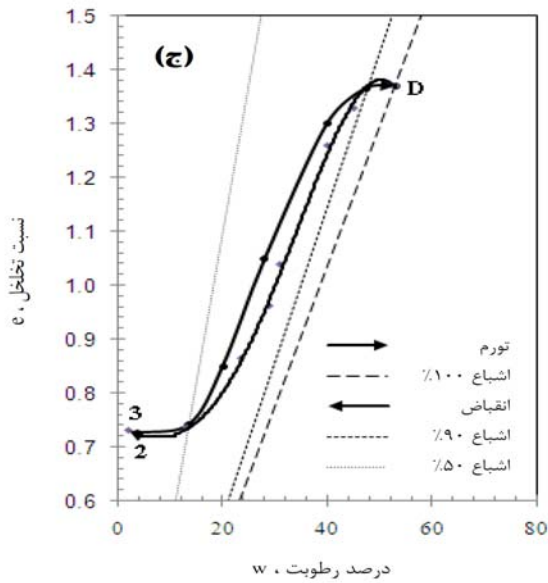
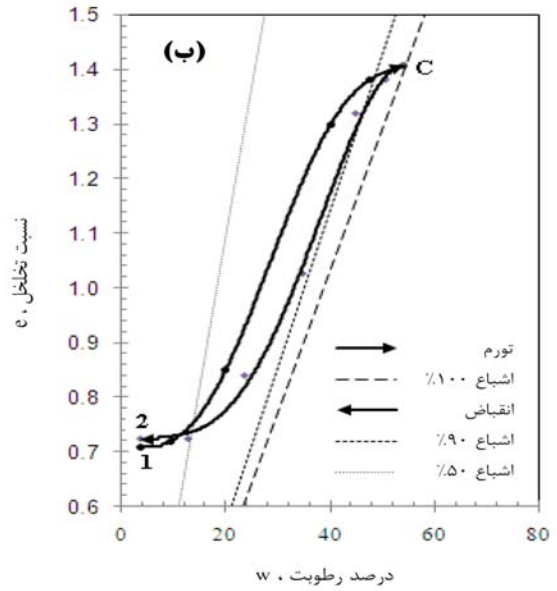
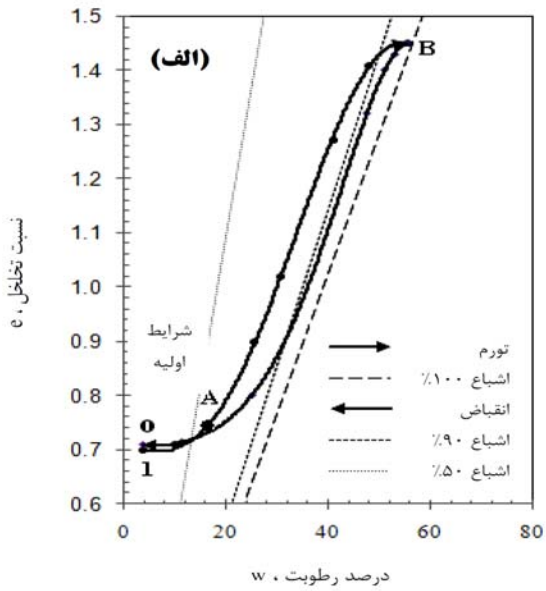

( ( ( ( :

Mishra et al. (2007)

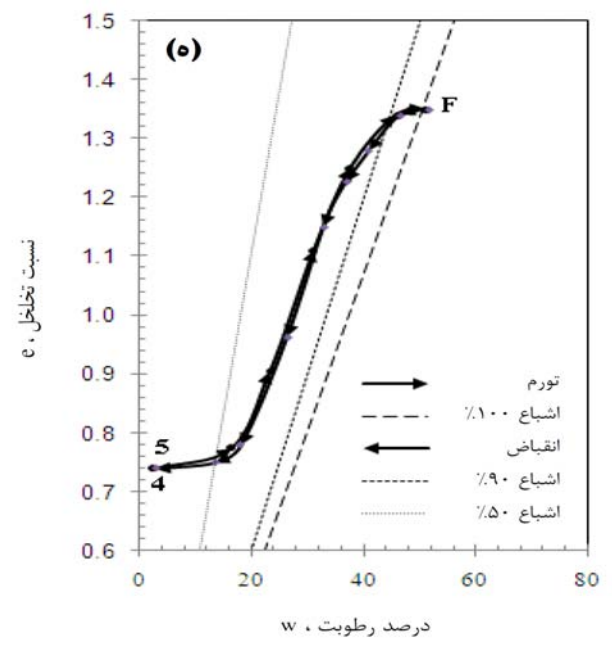

S

%

Sitharam et al. (1995); Tripathy et al. (2002)  
 S Ho et al. (1992);  
 Haines (1923)

S

S

(%)

S

- :  $\Delta H/H$  : V
- :  $\gamma_d$  : W
- : e : A
- : PI

## REFERENCES

- Adele, Dif., Werner, F., Alvemel. (1991). Expansive soils under cyclic drying and wetting. *Geotechnical Testing Journal*, Vol. 14, No. 1, pp. 96-102.
- Al-Homoud, A.S., Basma, A.A., Husein Malkawi, A.I. and Al-Bashabshah, M.A. (1995). Cyclic swelling behaviour of clays. *Journal of Geotechnical Engineering, ASCE*, 121(7), 562–565.
- Alonso, E.E., Gens, A. and Yuk Gahling, W.Y. (1994). Elasto-plastic model for unsaturated expansive soils. In: *Proceedings of 3rd European Conference on Numerical Methods in Geotechnical Engineering*, Balkema, Manchester, pp. 11-18.
- Basma, A.A., Al-Homoud, A.S., Malkawi, I.H. and Al-Bashabah, M.A. (1996). Swelling-Shrinkage behaviour of natural expansive clays. *Applied Clay Science*, Vol. 11, pp. 211-227.
- Chen, F.H. (1965). The Use of Piers to Prevent Uplifting of Lightly Loaded Structure Founded on Expansive Soils. In: *Proceedings of 4th International Research and Engineering Conference on Expansive Clay Soils*, Texas.
- Chu, T.Y. and Mou, C.H. (1973). Volume Change Characteristic of Expansive Soils Determined by Controlled Suction Test. In: *Proceeding of 3th International Conference on Expansive Soils*, Haifa, Israel, Vol. 1, pp. 177-185.
- Gens, A., Alonso, E.E. (1992). A framework for the behaviour of unsaturated expansive clays. *Canadian Geotechnical Journal*, Vol. 29, pp. 1013-1032.
- Gourly, C. S., Newill, D. and Schreiner, H. D. (1993). Expansive soils: TRL's research strategy. In: *Proceedings of the First International Symposium on Engineering Characteristics of Arid Soils*, 5-8 July., City University, London, England.
- Haines, W.B. (1923). The volume changes associated with variations of water content in soil. *Journal of Agricultural Science*, Vol. 13, pp. 296–310.
- Ho. D.Y.F., Fredlund, D.G. and Rahardjo, H. (1992). Volume change indices during loading and unloading of an unsaturated soil. *Canadian Geotechnical Journal*, Vol. 29, pp. 195-207.
- McKeen, R.G. (1992). A model for predicting expansive soil behavior. In: *Proceedings of 7th International Conference on Expansive Soils*, Dallas, USA, pp. 1-6.
- Mishra, A.K., Dhawan, S., Rao, S.M. (2007). Analysis of Swelling and Shrinkage Behavior of Compacted Clays. *Geotechnical and Geological Engineering and International Journal*, Vol. 26, pp. 289-298.
- Popescu, M. (1980). Behaviour of Expansive Soils with crumb structures. In: *Proceedings of 4th International Conference on Expansive Soils*, Denver, Colo, Vol. 1, pp.158-171.
- Sitharam, T.G., Sivapulliah, P.V. and Subba Rao, K.S. (1995). Shrinkage behavior of compacted unsaturated soils. In: *Proceedings of 1st International Conference on Unsaturated Soils*, Paris, France, pp. 195-200.
- Subba Rao, K.S. and Satyadas, G.C. (1987). Swelling potentials with cycles of swelling and partial shrinkage. In: *Proceedings of 6th International Conference on Expansive Soils*, New Delhi, India, Vol. 1, pp 137-147.
- Tawfiq, S. and Nalbantoglu, Z. (2009). Swell-Shrink behavior of expansive clays. In: *Proceeding of 2<sup>nd</sup> International Conference on New Developments in Soil Mechanics and Geotechnical Engineering*, Nicosia, North Cyprus, pp. 336-341.
- Tripathy, S., Subba Rao, K.S. and Fredlund, D.G. (2002). Water content-void ratio swell-shrink paths of compacted expansive soils. *Canadian Geotechnical Journal*, Vol. 39, pp. 938-959.